



AFLCMC... Providing the Warfighter's Edge



Agile Combat Support Portfolio Update

Col Quinones
Deputy PEO Agile Combat Support



Agile Combat Support Directorate



AFLCMC... Providing the Warfighter's Edge

239 programs

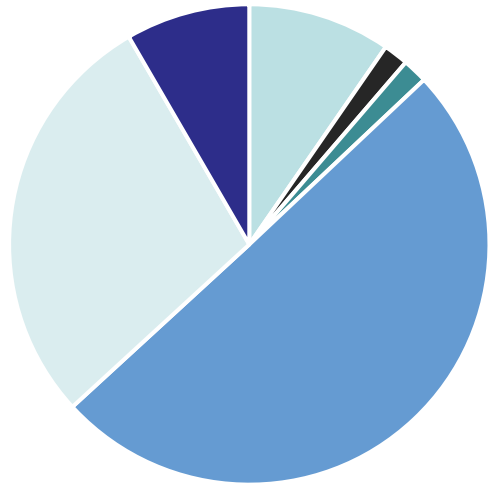

- 23 - Acquisition Master List
- 4 - Developmental (non-ACAT)
- 4 - Middle Tier Acquisition
- 120 - Sustainment
- 68 - Foreign Military Sales
- 20 - Support



approx. **1,600** people

Provides:

- Automatic Test Systems
- AFMETCAL
- Simulators
- Human Systems
- Combat Avionics
- Electronic Warfare
- Support Equipment & Vehicles





Automatic Test Systems Division



AFLCMC... Providing the Warfighter's Edge

MISSION: Provide and sustain world class enterprise test solutions that maximize warfighter core capabilities

VISION: Transform ATS / Automatic Test Equipment to a common Joint Technical Architecture (JTA) across Air Force enterprise—transportable to DoD; offers a state-of-the-art test solution and keeps the warfighters' equipment mission capable

Provides:

- Armament and Stores
- Avionics
- Electronic Warfare
- Software Loader/Verifier BIT
- Radar & IFF
- Specialized

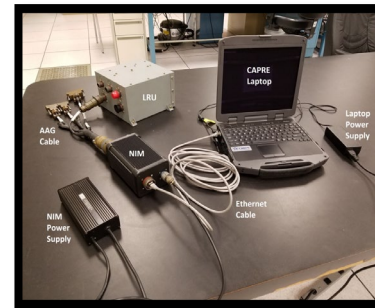
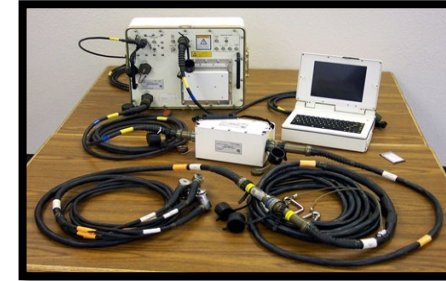



Air Force Metrology & Calibration

(AFMETCAL) Division

AFLCMC... Providing the Warfighter's Edge



MISSION: Develop, acquire, and sustain precision measurement capabilities in operating a worldwide calibration network to ensure accurate, reliable, and safe air and space systems performance



















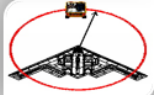

VISION: Advancing air and space power through measurement science, global operations and diverse partnerships

Provides:

- Calibration Ops & Sustainment
- Calibration Technology
- Electrical Calibration Domain
- Mechanical Calibration Domain
- FMS Sustainment
- FMS System Sales



“From PMEL, to Launch, to Target”

AFPSL Services	65 MAJCOM PMELs	Flight Line Depot MX	Weapon System
<ul style="list-style-type: none"> •Calibrations •~1,800 calibrations month •TO Development •~100 new/revised TOs/month 	<ul style="list-style-type: none"> •Calibrations traceable to AFPSL •Customer Support Capability •Support > 710,000 TMDE Items •TMDE Availability Rate \geq 93% 	<ul style="list-style-type: none"> •Support Equipment •Enhances Throughput •Supports Aircraft Availability 	<ul style="list-style-type: none"> •Mission Capability •War-Fighter Safety
AFPSL Calibrates Load Cells for PMEL Force Calibration Kits 	Load Cells for PMEL to Calibrate scales 	Weighing Platforms calibrated 	PDM checks weight Loadmaster checks load distribution 
Air Data Calibrators 	TTU-205 Pressure/ Temperature Test Set 	Check Air Data Computer on aircraft 	Reduced Vertical Separation Minimum (RVSM) checked 
Microwave Measurement Receivers 	PLM-4 Radar Signal Simulator 	Check Early Warning Radar Receiver 	B-2 Aircraft able to recognize Friend/Foe Signature 
Voltage Reference Standards 	467-3 Voltage Detector 	Check stray voltage on aircraft armament holders 	Aircraft allowed to carry armaments 
Standard Thermo Luminescent Detector (TLD) exposed at AFPSL 	AF Radiation Dosimetry Program, School of Aerospace Med (SAM), standardizes readers 	USAFSAM checks personal dosimeters CUI 	Safety of Nuclear & First Responders enhanced By Personnel Radiation Dosimeters 



Human Systems Division



AFLCMC... Providing the Warfighter's Edge

MISSION: Save & Improve Airmen's Lives

VISION: Save & Improve Airmen's Lives
Acquire & Support Human Systems to
Enhance Warfighter Performance,
Protection

Provides:

- Aeromedical
- Chemical, Biological, Radiological and Nuclear
- Combat Ready Airman
- Aircrew Performance
- Egress & Survival
- Sustainment



ALEP Block 2





Combat Avionics Division



AFLCMC... Providing the Warfighter's Edge

MISSION: Acquire, modernize and sustain training systems to enhance lethality and readiness by growing a talented workforce motivated to sharpen the warfighter's bite

VISION: To provide the premier warfighting digital twin – real, ready and lethal; capability delivered at the speed of relevance

Provides:

- Avionics
- Position, Navigation, & Timing (PNT)

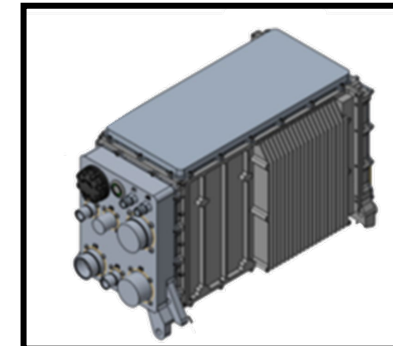
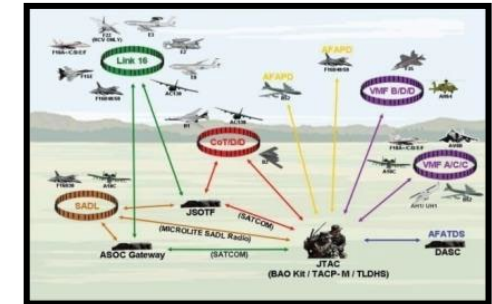



Electronic Warfare Division



AFLCMC... Providing the Warfighter's Edge

MISSION: Develop, acquire, and sustain precision measurement capabilities in operating a worldwide calibration network to ensure accurate, reliable, and safe air and space systems performance

VISION: Advancing air and space power through measurement science, global operations and diverse partnerships



Provides:

- Electronic Warfare
- Large Aircraft Infrared Countermeasures (LAIRCM)
- Electronic Warfare FMS





Support Equipment & Vehicles Division



AFLCMC... Providing the Warfighter's Edge

MISSION: Acquire and sustain war-ready support equipment & vehicles...responsive to the Warfighter, responsible to the Nation

VISION: Empowering the world's greatest Air Force by providing common support equipment & vehicles to the Warfighter through agile, integrated life cycle management

Provides:

- Aircraft Generation
- Base Support
- Mobility & Vehicles





Simulators Division



AFLCMC... Providing the Warfighter's Edge

MISSION: Acquire, modernize and sustain training systems to enhance lethality and readiness by growing a talented workforce motivated to sharpen the warfighter's bite

VISION: To provide the premier warfighting digital twin – real, ready and lethal; capability delivered at the speed of relevance

Provides:

- Air Combat
- Air Mobility
- Special Operations & AETC
- Operational Training Infrastructure
- Operational Training Environment/JSE
- FMS
- Analysis & Integration

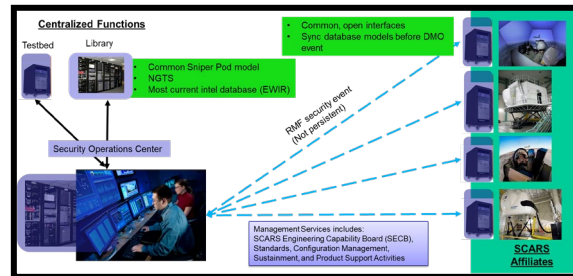



PEO Training



AFLCMC... Providing the Warfighter's Edge

“We need these changes now; we are out of time to reoptimize our forces to meet the strategic challenges in a time of great power competition.”
~ Secretary of the Air Force Frank Kendall



JSE



Threat Emitter

REOPTIMIZING FOR GREAT POWER COMPETITION

FOR THE DEPARTMENT OF THE AIR FORCE TO DETER AND, IF NECESSARY, PREVAIL IN ANY FUTURE CONFLICT, WE MUST REOPTIMIZE FOR GREAT POWER COMPETITION.

CORE AREAS

- DEVELOP PEOPLE
- GENERATE READINESS
- PROJECT POWER
- DEVELOP INTEGRATED CAPABILITIES



T-53A



C-130J MATS



JCT TRS



SCARS



T-38 Talon



T-7A Red Hawk

PEO TRAINING



AFPEO Training 1.0

AFLCMC... Providing the Warfighter's Edge



Enterprise Training & Test
Cross-Cutting Enabler



Notional AFPEO Training Spectrum



AFLCMC... Providing the Warfighter's Edge

Constructive

Virtual

Live

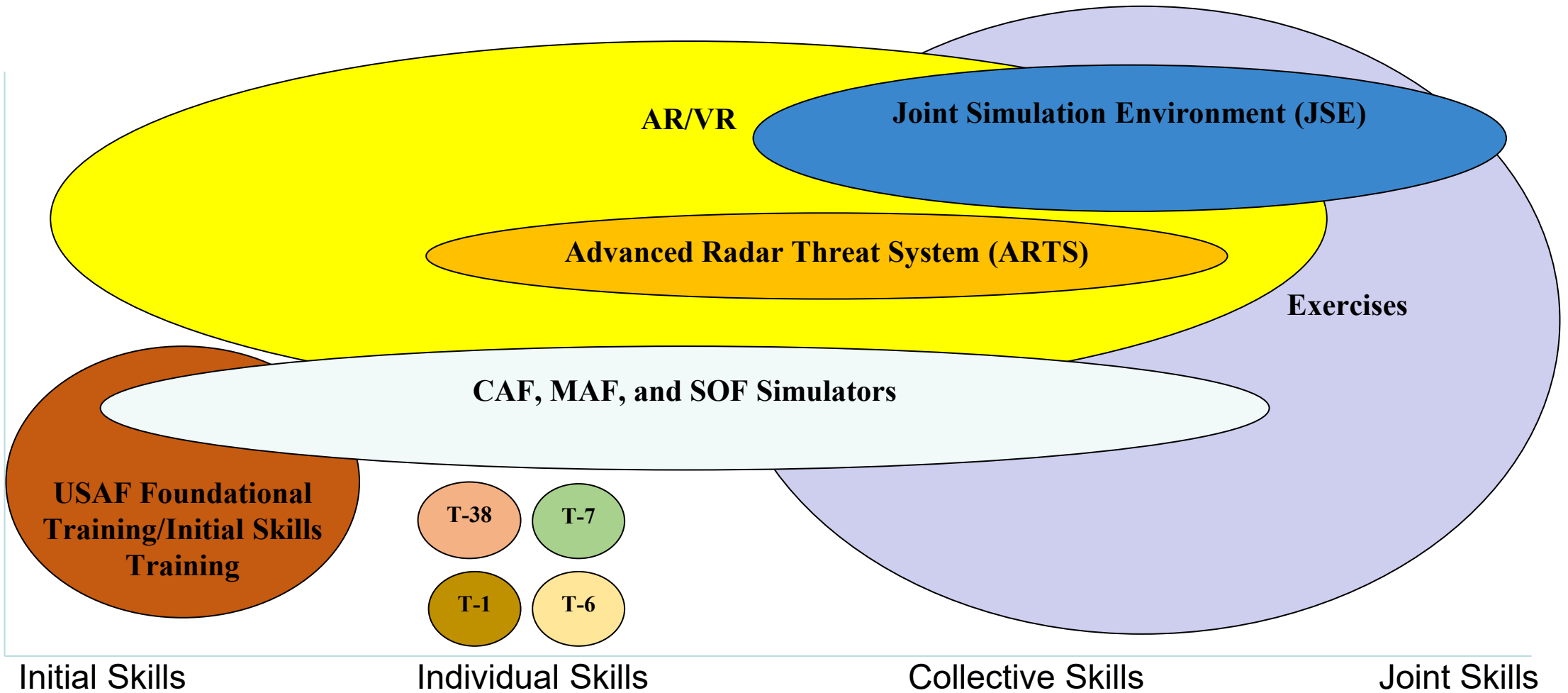



Training & Test Cross-Cutting Operational Enabler (COE)

AFLCMC... Providing the Warfighter's Edge



SECAF's Operational Imperatives



New ways to train and test

Blue Force
Training

Red Force
M&S

Combat
Support
Training

Big Data
Management

PEO Training: Acquire and Integrate



Training Directorate 2.0

AFLCMC... Providing the Warfighter's Edge



AFPEO for Training



“[Training is] inappropriately weighed in favor of what is available to fight a narrow range of scenarios today with what we currently have on hand.”
Gen Charles Q. Brown and Gen David H. Berger



Next Steps



AFLCMC... Providing the Warfighter's Edge

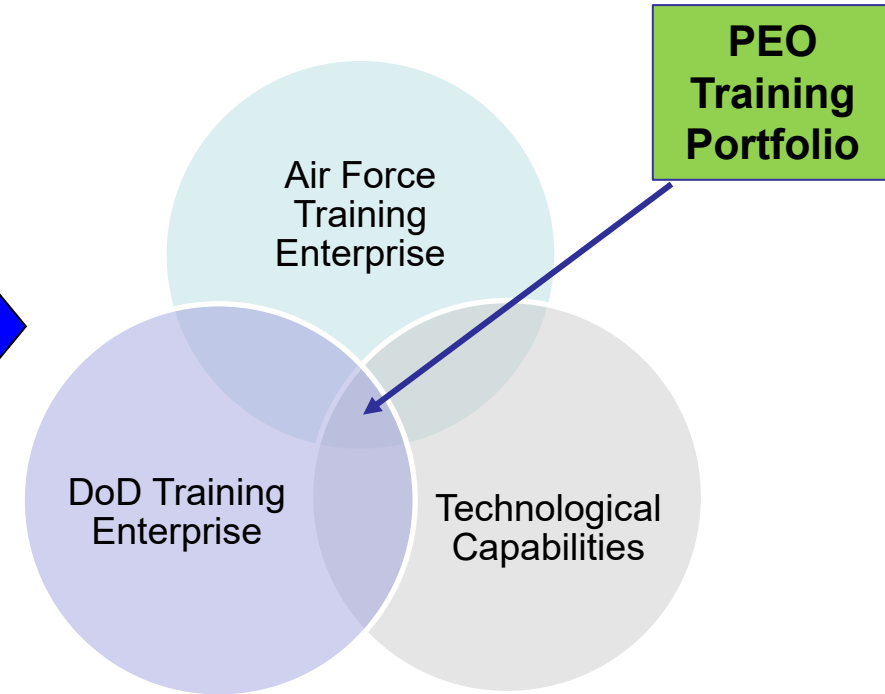
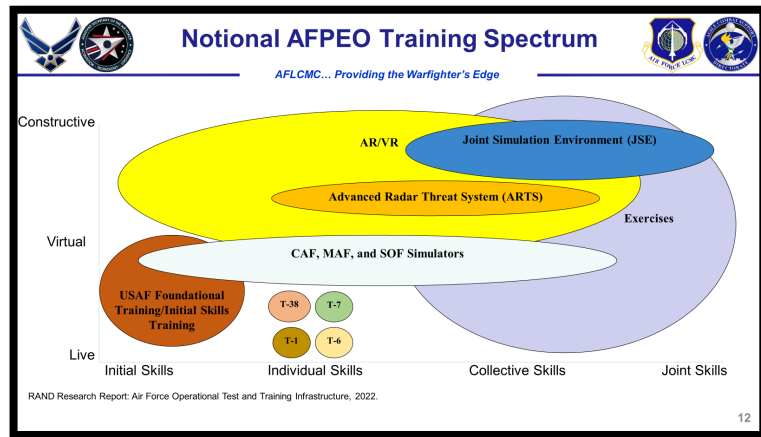

Next Generation Training Capabilities



Agile Combat Support

AFLCMC... Providing the Warfighter's Edge



**Every Airman
Every Mission
Every Day!**



We ARE...AF Agile Combat Support!!!